



ShinyStar Wood

FACTORY : CHINA/VIETNAM/MALAYSIA/COLOMBIA



PANTING



WATERPROOF



DURABLE



SUSTAINABLE



WARRANTED



Company Profile

Founded in 2008, Shinystar is professionally engaged in the research, development and production of decorative mouldings. We export over 2,000 containers yearly to provide clients with the most premium customer service.

Products are exported to Australia, New Zealand, the United States, Canada, Europe, Chile, and Spain. And have been widely praised within China and abroad.

CONTENTS

POLYSTYRENE MOULDINGS

1. WHITE SERIES

PS SKIRTING BOARDS	1-2
PS WALL MOULDINGS	3-4
PS CROWN MOULDINGS	5

2. WOOD SERIES

.....	6-7
-------	-----

3. HOT SELLING COLORS

.....	8-11
-------	------

4. HOT SELLING MODELS

.....	12-14
-------	-------

5. FLOOR T-MOULD AND EDGE TRIM

.....	15-16
-------	-------

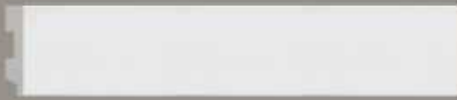

SSW431-W1



SSW132-W1

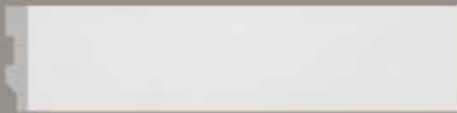

SSW133-W1

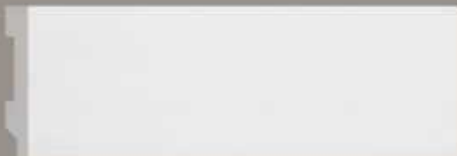

SSW37-W1



SSW413-W1

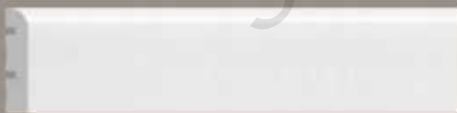

SSW136-W1

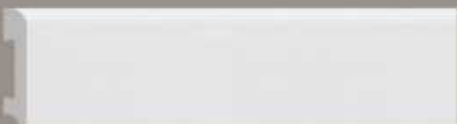

SSW468-W1

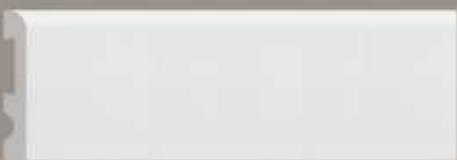

SSW448-W1

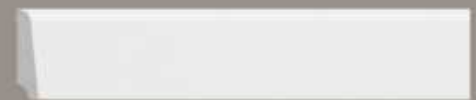

SSW448-W1



SSW307-W1



SSW411-W1

PS skirting boards



SSW107-W1

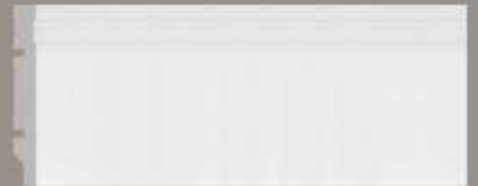

SSW113-W1

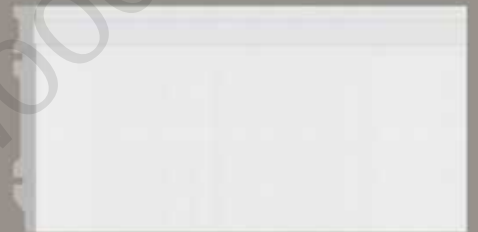

SSW414-W1

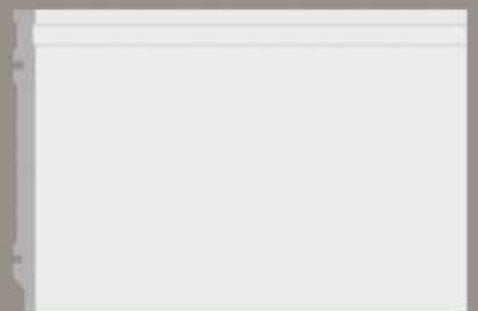

SSW326-W1

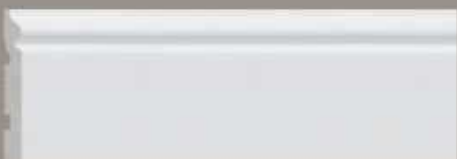

SSW437-W1



SSW435-W1



SSW397-W1

PS wall mouldings

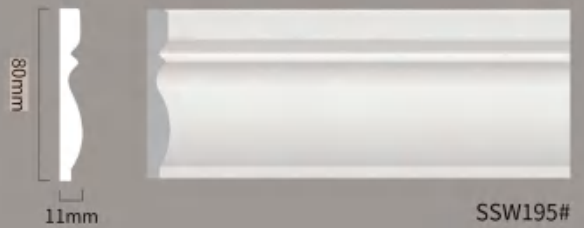
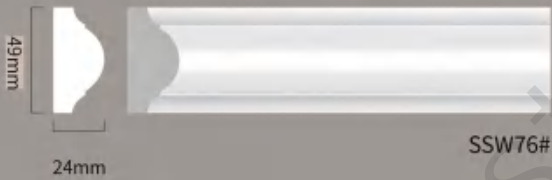
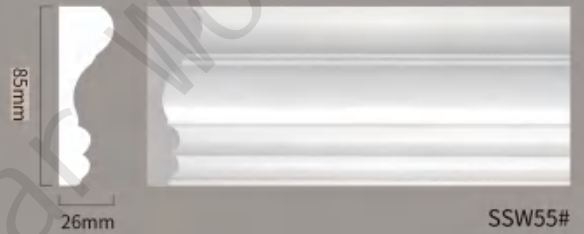
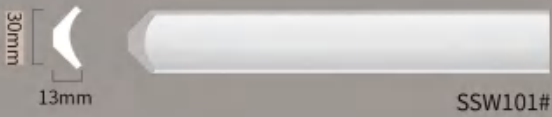

PS wall mouldings

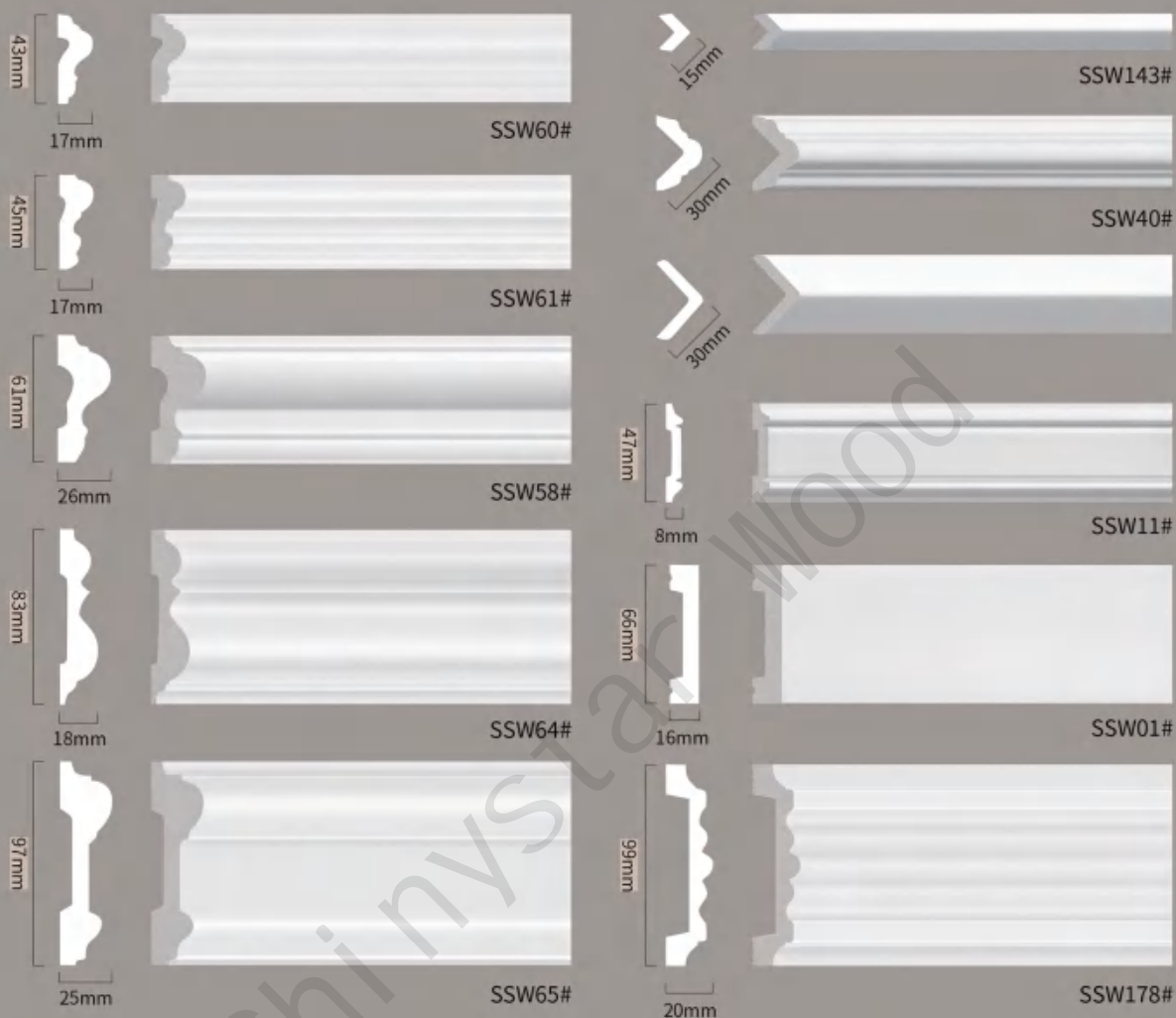

PS crown mouldings

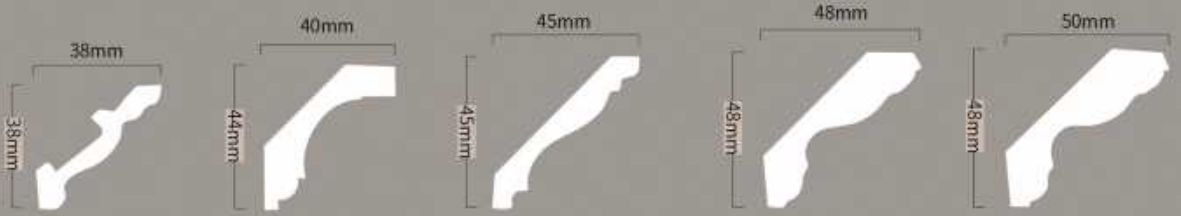

SSW194#

SSW98#

SSW880#

SSW1008#

SSW496#

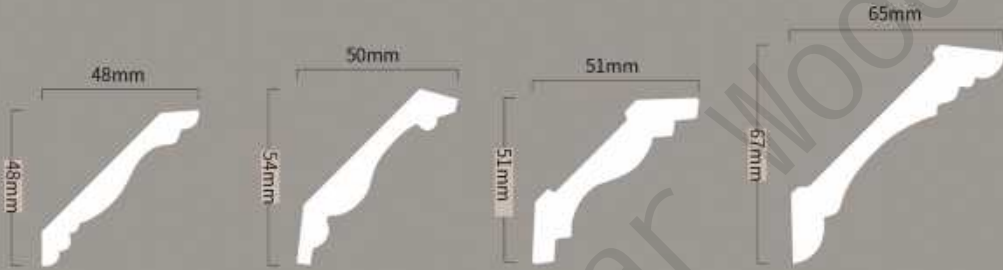

SSW1040#

SSW335#

SSW80#

SSW124#



SSW98-W1



SSW496-W1



SSW124-W1



Wood Series



SSW581



SSW581-7032



SSW581-71151



SSW581-1658EM



SSW581-1678



SSW581-696



SSW581-1714



SSW581-1153



SSW581-1238



SSW581-1187



SSW581



SSW581-7188



SSW581-485



SSW581-1578EM



SSW307



SSW307-610



SSW307-7227



SSW307-7055T



SSW307-1269EM



SSW307-7226T



SSW307-730



SSW307-372



SSW307-38047



SSW307-4033T



SSW307



SSW307-15013T



SSW307-1371T



SSW307-1823

Hot-selling Colors



-1597



-7032



-1449P

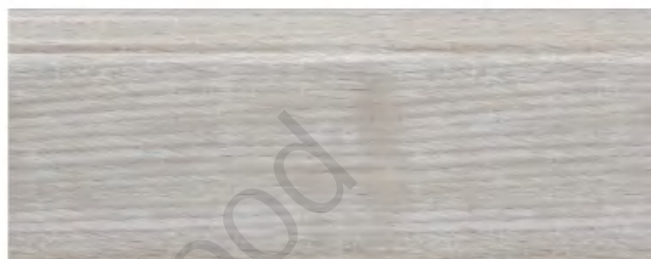

-1395



-71151



-1658EM



-1720



-662



-1714



-71152



-1154



-610



-1678



-1401EM



-696



-1134



-L73M



-7041



-485



-7188

Hot-selling Colors

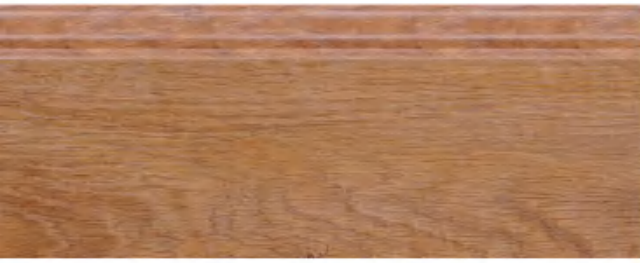

-7088



-787FI



-1617P



-56



-1371EM



-1517



-1269EM



-1465



-1207



-1287EM



-1491

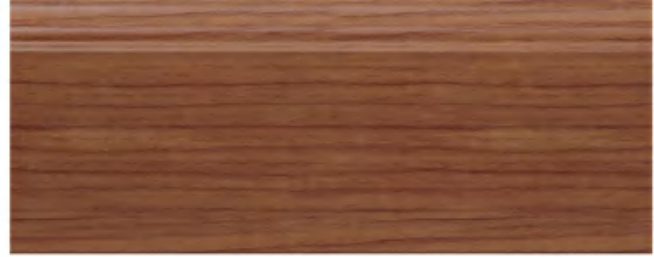

-1153



-730



-1140EM

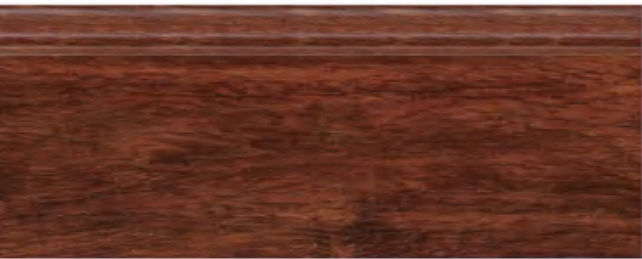

-7095

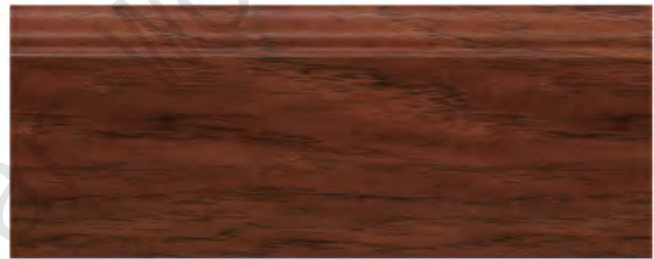

-1238EM



-7085



-1187

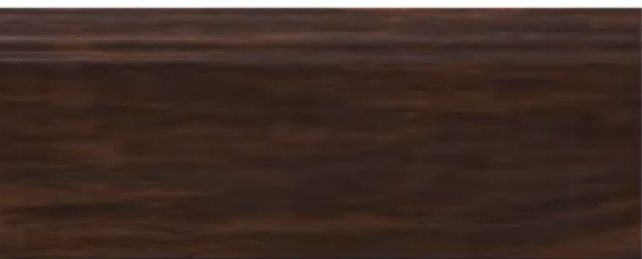

-1511P

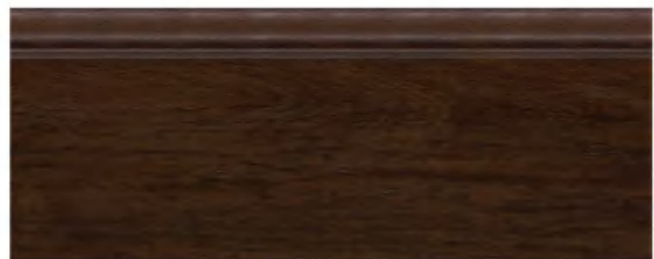

-1284EM

Hot-selling Models

<6cm



SSW358



SSW367



SSW768

6~9cm



SSW67



SSW719



SSW350



SSW535



SSW368

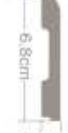

SSW751



SSW408



SSW359



SSW131



SSW58



SSW493



SSW351



SSW365



SSW369



SSW509



SSW518



SSW726



SSW741



SSW132



SSW107



SSW307



SSW158



SSW82



SSW222



SSW117



SSW755



SSW70



SSW136



SSW13



SSW59



SSW60



SSW526



SSW39



SSW482



SSW196

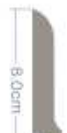

SSW731



SSW581



SSW581



SSW761



SSW534

6~9cm



9~12cm

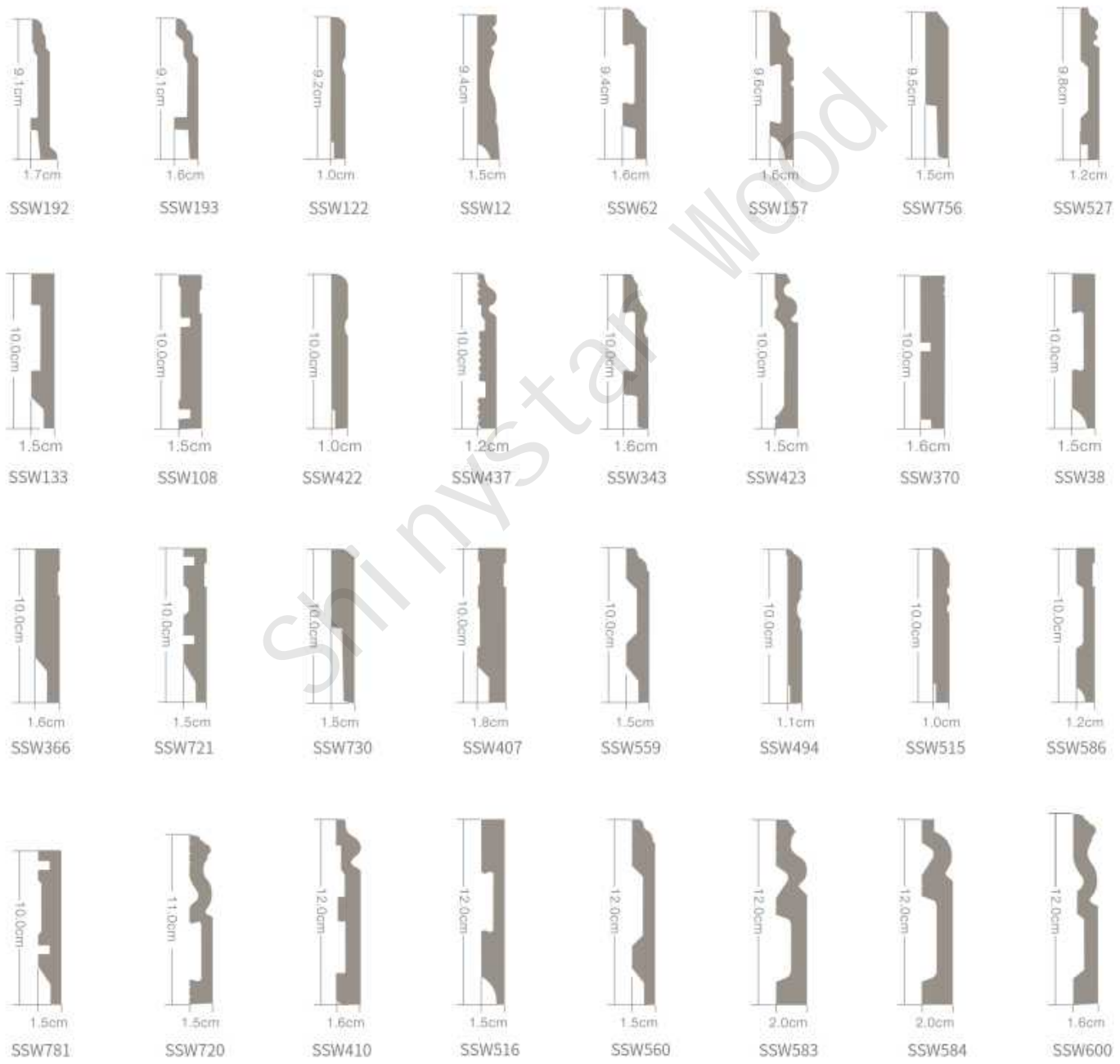

Hot-selling Models

9~12cm



>15cm



Floor T-Mould and Edge Trim

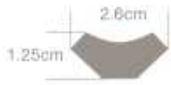

SSW567-W1



SSW569-W1

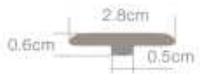

SSW-YP30



SSW-413T



SSW-508



ShinyStar Wood



SSW-YG30

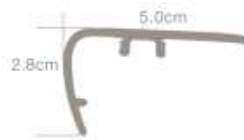

SSW-5228

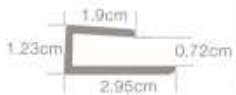

SSW-08F

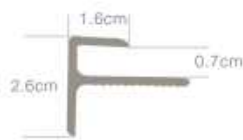

SSW-08A

Floor T-Mould and Edge Trim

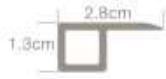

SSW109-0105P



SSW-2111



SSW-2111



SSW-2525

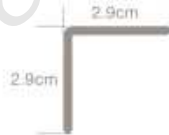

SSW-3220

Installation

Installation model 1: Gluing

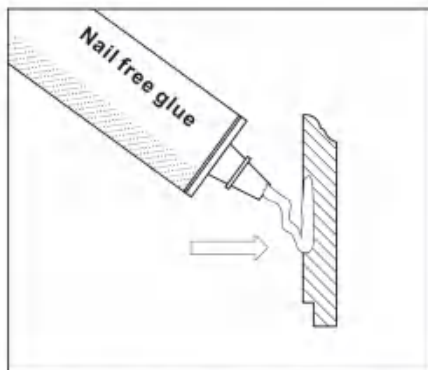

Apply Nail free glue equally to the notch of the skirting board.

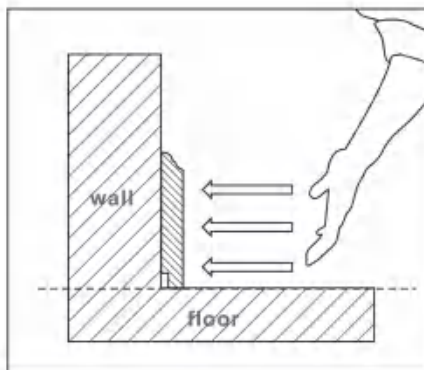

Clean the wall surface, make sure it flat before you place the skirting board to the wall, press tightly until it stick the wall.

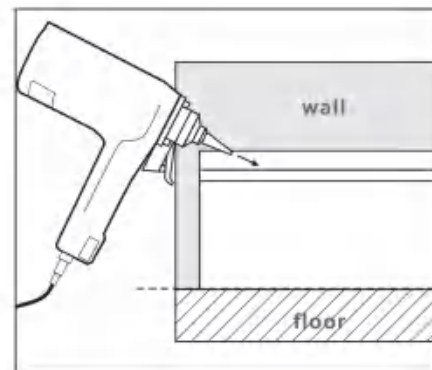

Use nailer to nail it when necessary. Cover the nail head with lacquer putty or color pen.

Installation model 2 : Installation buckle

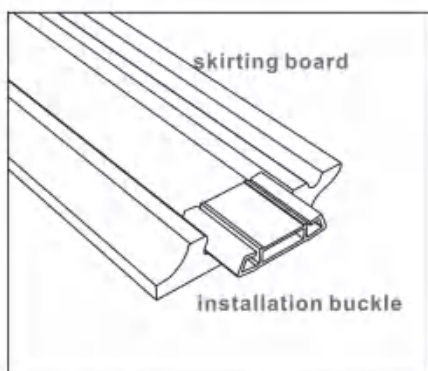

Cut a small piece skirting board (around 20cm), fix the installation buckle with skirting board as the picture.

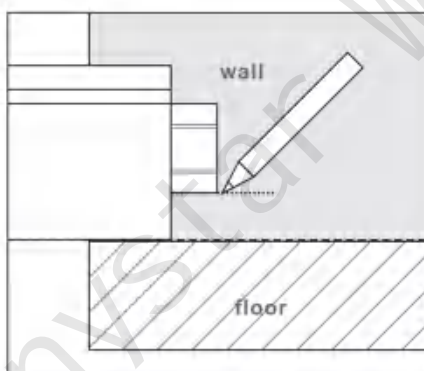

Mark the place for nail fixing. 40cm is a suitable interval for two buckles. The interval should be narrowed accordingly around the skirting board joint place.

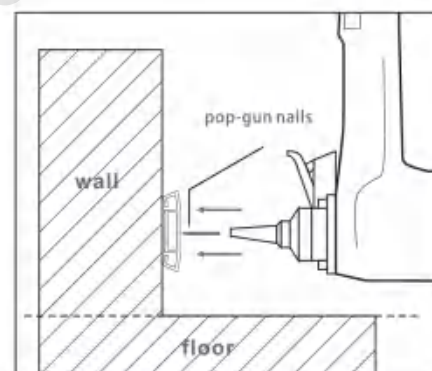

Use professional tool (Pop-gun is better) to fix the installation buckles on the marked place. Make sure do not damage water or wire pipes.

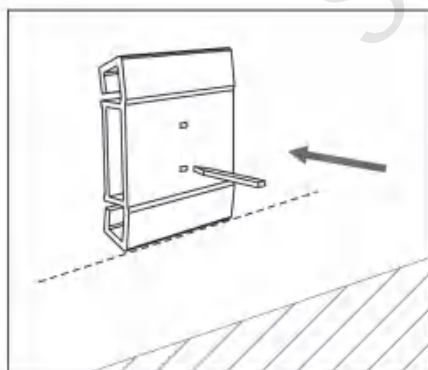

In order to make sure the installation buckle is on the right place, please use two nails to fix it. Please refer to above picture for the nails place.

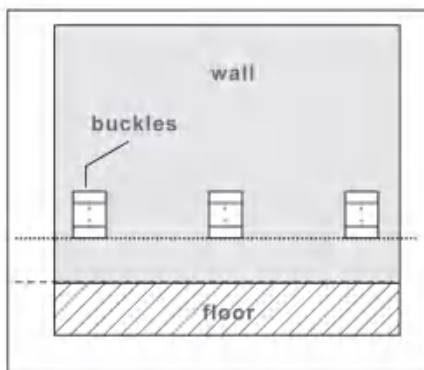

To fix the installation buckles on the wall in proper sequence, same as the picture.

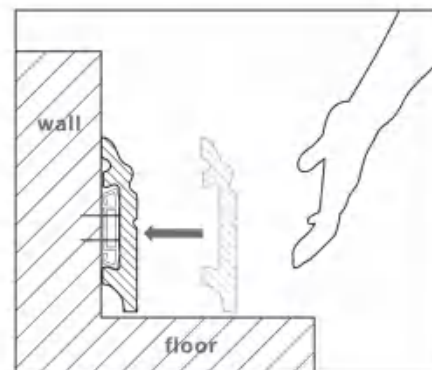

Press the skirting board to the installation buckles in proper sequence and fixes it properly.

Tools & Accesories



Cutting Machine



Steam Nailer



Nail Gun



Strong nail free glue



Plastic buckle



Sexternal and Internal corner.
Plug. Butt



Steam nail



Clear cloth



Masking tape



Double-sided from tape



Tape measure



L-square

Demonstration of inner / outer corner, flush joint, plug:

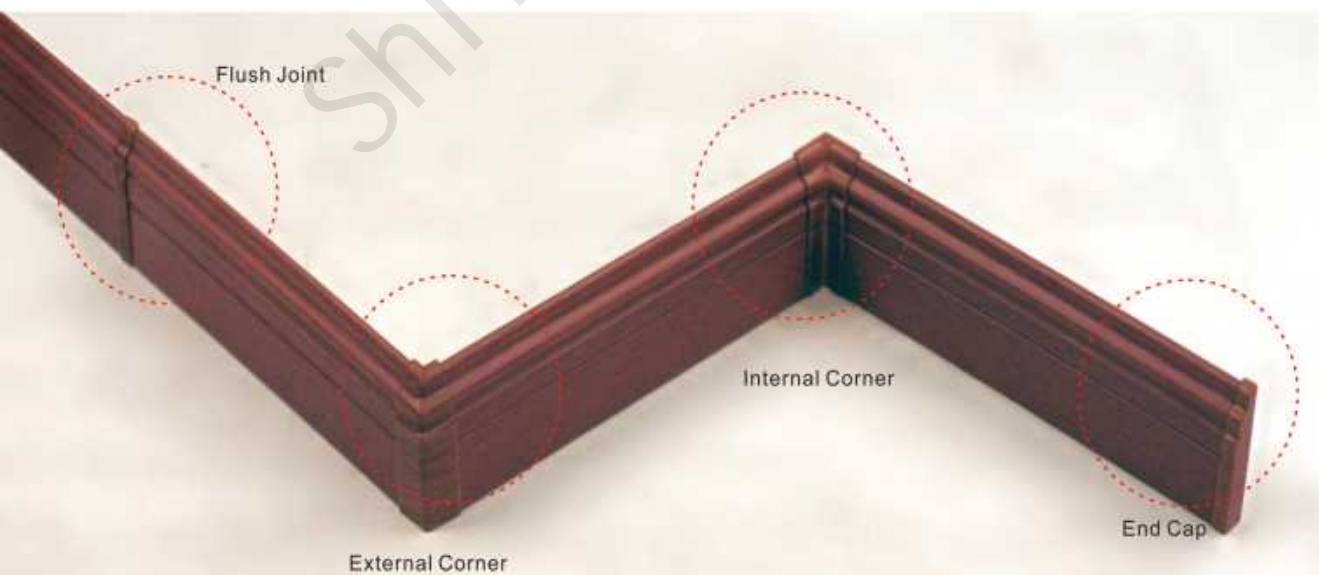



Shinystar Wood

Shanghai Shinystar Wood Co., Ltd.

More than 15 years

Factory: China/Vietnam/Malaysia/Colombia

Contact information

Web : www.shinystarwood.com

Phone: +86-21-34719155

Mobile: +86 15921724860

E-mail : sales@shinystarwood.com

Address: Room 1205, Building G, NO.1777

Hualong Road, Qingpu District, Shanghai



PANTING



WATERPROOF



DURABLE



SUSTAINABLE

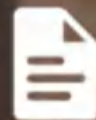

WARRANTED